

CE IE3

MADE IN ITALY



**INDUSTRIAL range**



**MICRO - PLUS**

Belt-driven oil-injected rotary screw compressors



Fixed and Variable Speed  
2.2-75 kW

# Company Profile

FINI boasts more than 70 years of experience and is one of the most important global organisations in the professional and industrial compressed air sector. Synonymous with quality and professionalism, the Fini brand not only provides one of the most comprehensive ranges in the field of rotary air compressors, but above all Fini is now established as a global reference point in terms of quality and technology recognised throughout the industrial compressed air sector.



All Fini industrial compressors are **MADE IN ITALY** and are designed for heavy duty use and distinguished by offering unique and advanced technologies that provides energy saving solutions that work!

► Our compressors offer the ideal solution to the needs of larger-scale industry as well as smaller and mid-sized companies, where compressed air is a most important source of energy.

Fini Screw Compressors are designed for continuous duty in the most arduous operating conditions, with a special attention to reducing energy consumption, lowering operating and maintenance costs along with offering simple installation and ease of use.

► The entire production process, from project design and research through to packaging of the final product is carried out at our facilities in Italy.

Our highly skilled work force are dedicated to supporting the manufacturing and assembling activities. The continuous control and monitoring of each manufacturing process grants the utmost precision at every step, in order to achieve the highest quality, supreme product reliability and flexibility of use.

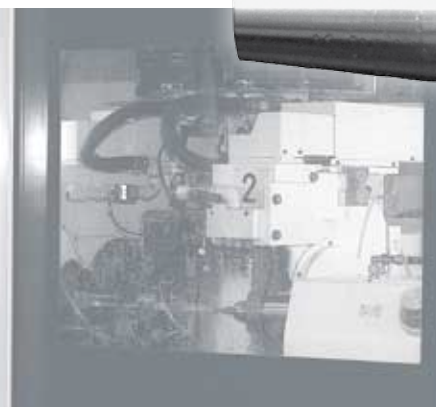
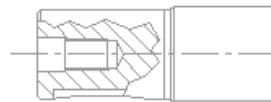

# Innovation, Quality and Know-how

Our engineering philosophy is based on the selection and highly controlled assembly of the most reliable and efficient technical solutions. The constant pursuit of excellence in quality along with an innovative spirit and particular attention to the customers demands, are the values that have always characterised FINI and its products.



► The continuous investment in technical design and product innovation has allowed FINI to take a further step forward in the sector, with the launch of the latest range of industrial air compressors- **MICRO and PLUS Series: oil-injected belt-driven rotary screw compressors**, in an extensive range from 2.2 kW to 75 kW.

► During production all of the assembly and testing of products is performed on automated assembly lines that utilise the latest robotic systems. The use of the most advanced and modern machine tools in manufacturing coupled with the employment of advanced controls and processes have been a major focus for the Company representing a very significant investment in order to create products that exceed the quality standards demanded by the market.

Since 1996, the Company has certified its quality systems in compliance with UNI EN ISO 9001.

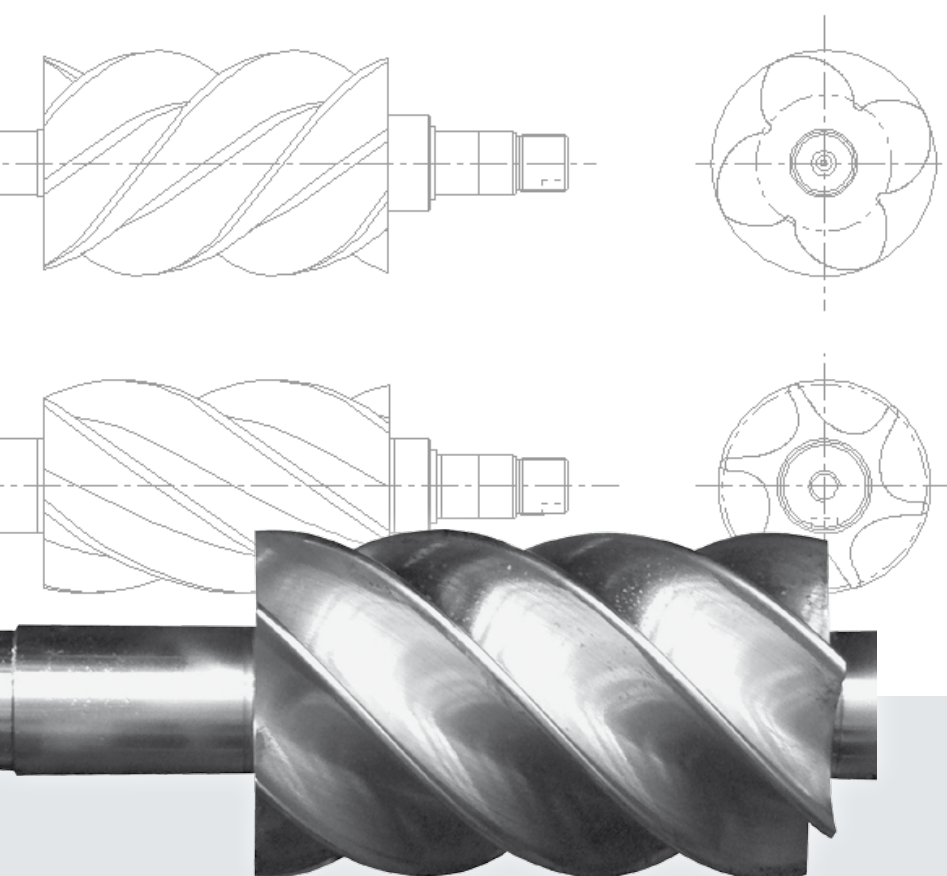



# Our TARGET: Maximum efficiency, lower energy consumption and total convenience.

The new belt-driven oil injected Micro and Plus screw compressors have been designed to minimise energy costs, without sacrificing performance. The modularity and flexibility of these products provide multiple solutions suitable for different user's requirements: with or without air receiver, with or without refrigerated dryer, in fixed speed or variable speed formats.



# Why you should choose a Fini SCREW compressor?

- ▶ To control and reduce operating costs.
- ▶ To provide the most modern, compact, robust, reliable and quiet rotary screw compressor.
- ▶ To provide a continuous source compressed air.
- ▶ To increase operational efficiency in all areas where compressed air is used.
- ▶ To save energy and reduce CO<sub>2</sub> emissions.

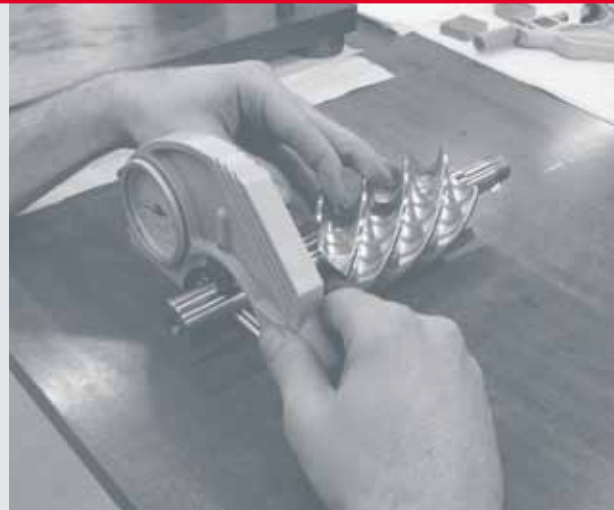

## High energy saving

The choice of high quality components, combined with our high performance air-ends and **Premium Efficiency IE3 motors**, ensure reduced power consumption, substantial energy savings and exceptional performance. Furthermore, the IE3 motors reduce CO<sub>2</sub> emissions: an important contribution to protecting the environment.

## Plug&Play

Micro and Plus compressors are thoroughly tested at our factories to ensure they are ready for immediate use following delivery, thereby saving time and cutting installation costs.



## Low noise level

Micro and Plus compressors are very quiet: the use of very efficient soundproofing materials means that they are suitable for installation in any working environment.

## High reliability

The use of premium components from primary global manufacturers along with our advanced assembly with strict quality control and testing, results in a final product that offers a long service life with maximum reliability and fewer maintenance interventions.

## High efficiency

Higher air output performance is a key focus for the renowned FINI project engineering and design team. The new Micro and Plus series follows this tradition by offering premium performance levels across the entire range.

## Very compact design

The very compact design enables Micro and Plus compressors to be installed close to the application reducing installation costs and improving efficiency.

Our air-ends, inverters and controllers are covered by **2 YEARS WARRANTY**

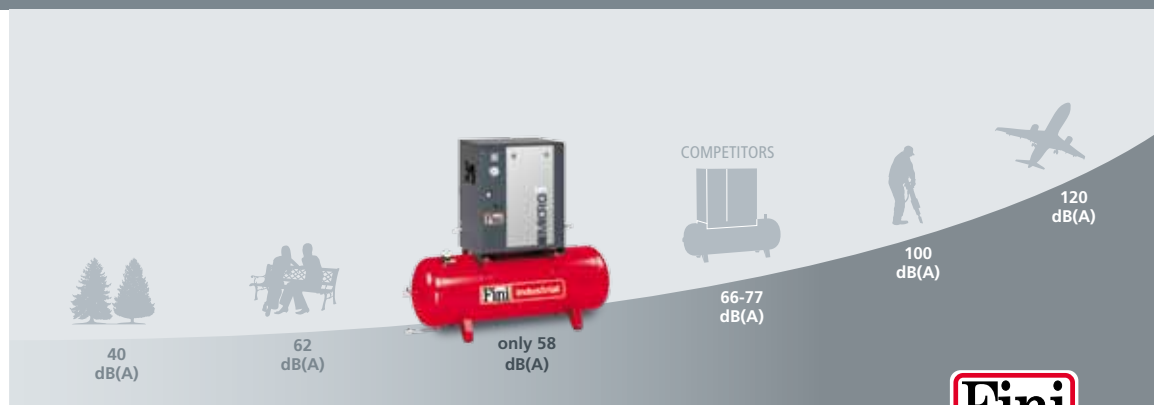

# Designed to offer a long service life



## 1 Innovative cooling system

The cooling system is among the most innovative in the field. A thermostatic controlled centrifugal fan keeps the temperature of the entire compressor to specific tolerance and at a constant level, avoiding temperature peaks that can be harmful for the correct operation of the compressor. The action of the fan, combined with the efficiency of the oversized oil cooler, guarantees the ideal operation of the compressor in differing and even extreme climatic conditions.

The "silent" fans along with the specially developed labyrinth ventilation and the use of high quality soundproofing materials ensure one of the lowest acoustic levels of any air compressor.

## 2 Efficient transmission

The POLY-V belt drive ensures significantly lower power losses and three times longer service life compared to standard range "V" type belts fitted to other compressors on the market. simple belt tensioning is carried out through a sliding belt tensioner.

## 3 High performance flexible tubing

All air-oil circuit flexi-tubes are of premium quality and made of multi layer rubber covered with a metal mesh which are resistant to very high temperatures and capable of operation at high pressure.

## 4 Intake valve

The intake valve is entirely designed and manufactured at our facilities. This most important device, adjusts the compressor's operation to guarantee minimum pressure during idle running and maximum savings upon start-up.

## 5 Pressure transducer

The use of a digital transducer guarantees an accurate and stable function during operation. It allows direct modification of the working pressure from the electronic controller without any mechanical intervention.





# Noise and temperature under control

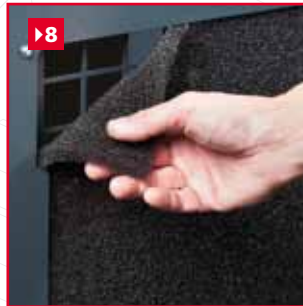

## ▶10 High performance ROTARY SCREW AIR-ENDS

The Fini FS air ends are entirely designed, produced and tested at our Italian facilities: the special design of the screw profile ensures high performance, low temperature and reduced energy consumption.

## ▶6 SPIN-ON filters

Routine service parts that are easy to remove and replace offering long service intervals for lower maintenance costs.

### Air filters

Protecting the compressor the oversized filter mass with double filtering media allows operation even in arduous environments.

## ▶7 Minimum pressure valve

Manufactured and designed in house using advanced anti corrosive materials and fully machined at our facilities, to grant maximum reliability in any operating conditions.

## ▶8 Cleaner components in any conditions

A cabinet prefiltering panel (available from 18.5 kW) inhibits dust and dirt from entering the inside of the compressor cabinet increasing the life of air filters and the drive belt by 15%, whilst keeping coolers cleaner thereby reducing operating temperature.

## ▶9 Simple maintenance

All of the internal mechanical and service parts are easy to access, for fast and simple routine maintenance.

# MICRO 2.2-5.5 kW: simple, silent and economical.

- ▶ Extremely quiet operation.
- ▶ Very compact design.
- ▶ Anti-rotation system.
- ▶ Low maintenance costs.
- ▶ Ease of installation and use.
- ▶ Plug and play.



The MICRO range is available in 2 versions:

- **MICRO "SE" 2.2-4 kW:** electromechanical ON/OFF switch, with motor protection.  
The pressure gauge and hour counter are included in the control panel.  
Easy to use, no idle running means considerable energy saving.

- **MICRO 4-5.5 kW:** star-delta starter, including the ETMII electronic controller, which controls the complete operation of the machine.

## Micro SE 2.2-3.0-4.0

### 2.2-4 kW

#### Available versions:

- floor mounted compressor
- compressor + air receiver
- compressor + air receiver + air dryer  
(air receiver: 200 liters)

**Air-end:**  
FS14



**Controller:**  
-

-

Fixed speed

## Micro 4.0-5.5

### 4-5.5 kW

#### Available versions:

- floor mounted compressor
- compressor + air receiver
- compressor + air receiver + air dryer  
(air receiver: 200, 270 or 500 liters)

**Air-end:**  
FS14



**Controller:**  
ETMII

ETMII



Fixed speed



# PLUS 7.5-15 kW: the modular choice.



- ▶ Extremely quiet operation.
- ▶ Very compact design.
- ▶ High efficiency.
- ▶ Low R.P.M.
- ▶ Ease of installation and use.
- ▶ Plug and play.

### Dryer module ▶

The models with air receiver are also available with dryer ("ES" versions): supplied ready to operate with a minimum of installation.



### Condensate ball valve (1)

Receiver-mounted models with ball valve for convenient discharge of condensate (refer to local regulations).

### Easy to transport (2)

The machine is particularly easy to lift with a fork truck or hand truck thanks to a steel bar secured between the feet at the base of the air receiver (both at the front and to the side).

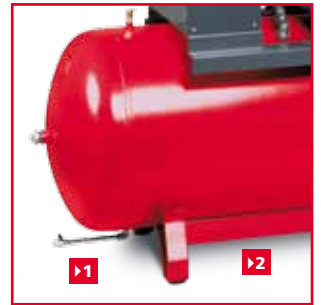

## Plus 8-11-15

### 7.5-15 kW

#### Available versions:

- floor mounted compressor
- compressor + air receiver
- compressor + air receiver + air dryer (air receiver: 270 or 500 liters)

**Air-end:**  
FS26 TF



**Controller:**  
ETMII



Fixed speed

## Plus 16

### 15 kW

#### Available versions:

- floor mounted compressor
- compressor + air receiver
- compressor + air receiver + air dryer (air receiver: 500 liters)

**Air-end:**  
FS50 TF



**Controller:**  
ETMII



Fixed speed

# PLUS 18.5-37 kW: new design with higher performance.

The new PLUS compressors from 18.5 to 75 kW are entirely designed and manufactured so that they function as an integrated system with the maximum efficiency.

All of the most important components within the compressor are manufactured in house using state of the art methods including the use of very modern machine tool and process control technology: this allows full control of the production cycle and maximum control in respect to the total quality of the entire compressor.

The cooling air flow, channeled by the thermostatic controlled centrifugal fan, provides maximum circulation to the oversized combined oil/air heat exchanger: this permits the compressor to run at optimised temperature even in severe ambient conditions.



◀ **Dryer module**  
Plus 18.5, 22, 31 and 38 models with dryer module (ES) provide clean, dry air that improves the system's reliability, avoids costly downtime and production delays, and safeguards the quality of the final product.



## Plus 18.5-22

18.5-22 kW

### Available versions:

- base compressor
- compressor + air dryer

**Air-end:**  
FS50TF



**Controller:**  
ETIV



Fixed or Variable Speed (Plus 22 VS)

## Plus 31-38

30-37 kW

### Available versions:

- base compressor
- compressor + air dryer

**Air-end:**  
FS100  
FS130



**Controller:**  
ETIV



Fixed or Variable Speed (Plus 38 VS)

# PLUS 45-75 kW: a quality choice.

- ▶ Extremely quiet operation.
- ▶ High performance screw air-end.
- ▶ Ease of access for routine maintenance.
- ▶ Low maintenance costs.
- ▶ Ease of installation and use.
- ▶ Prefiltering panel.



**Plus 45-55**

**45-55 kW**

**Available versions:**  
- base compressor

**Air-end:**  
FS130



**Controller:**  
ETIV



Fixed speed



**Plus 56-75**

**55-75 kW**

**Available versions:**  
- base compressor

**Air-end:**  
FS250



**Controller:**  
ETIV



Fixed or Variable Speed (Plus 56 and Plus 75 VS)



# Advanced electronic controllers

## ETMII

Installed on models from 4 to 15 kW.



- ▶ Four maintenance timers (air filter, oil, oil filter, oil separator).
- ▶ Automatic re-start after power failure (subject to safety conditions).
- ▶ Cooling fan temperature control.
- ▶ Compressor remote start facility.
- ▶ Integrated phase sequence relay.

Controller with multi-function backlight display, the menu is alphanumeric type. The main screen display indicates:

- Working pressure (offload/load);
- Oil temperature;
- Total working hours;
- On-load working hours;
- Compressor status led (stand-by, offload, load);
- Hours remaining before maintenance.

## ETIV

Installed on models from 18.5 to 75 kW.



Controller with multi-function backlight LCD graphic display, the menu is drop down type. The main screen display indicates:

- ▶ operating pressures;
- ▶ oil temperature;
- ▶ compressor status (stand-by, un-loaded, loaded);
- ▶ fan status (off/on);
- ▶ date and time;
- ▶ remaining hours for maintenance;
- ▶ flow rate supplied percentage
- ▶ Duty cycle compressor (tot. hours a carico)

### ▶ Weekly programming

With the ETIV controller, it is possible to set up to 9 independent operating programs. For each program it is possible to set the switching on and off times, the days of the week in which it must work and the relative pressure range. In case of a system with several compressors, both at fixed and variable speed, it is possible to set various programs to create a "virtual network" (without the need to physically connect them together).

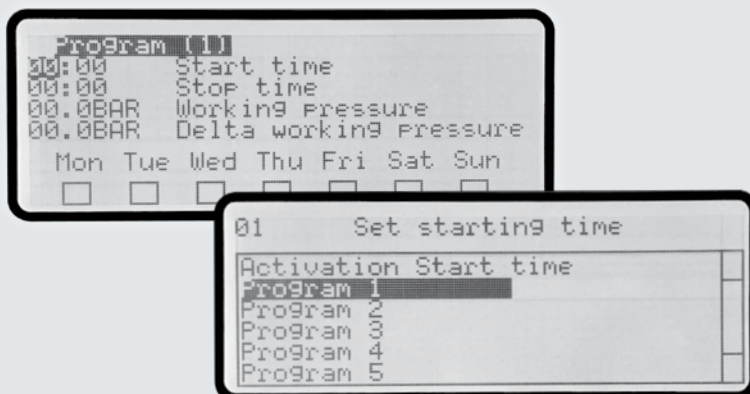

# Variable speed drive

Nowadays, the reduction of the energy consumption has become a global challenge in terms of environmental impact. Reducing power consumption and protecting our valuable energy resources represents one of the greatest global environmental challenges of our times.

**The Plus series version with 22, 37, 55 and 75 kW electric motor are available in a variable speed drive version, providing high performance combined with the most effective energy saving solution.**

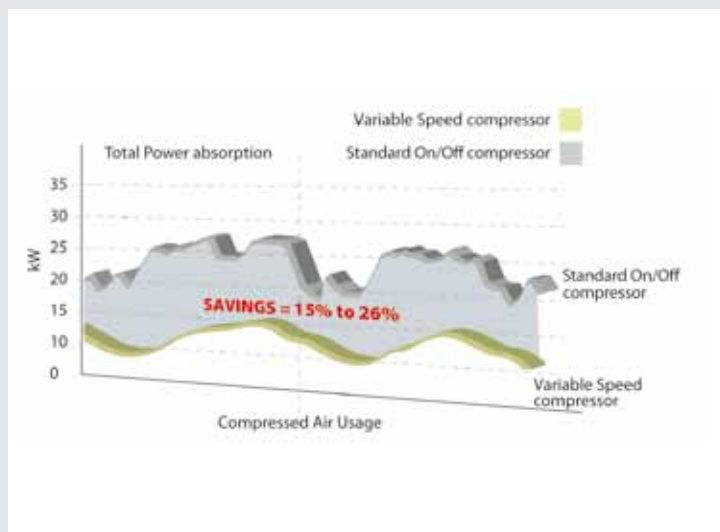

The graph below shows the significant energy saving using variable speed compressors in a typical installation.

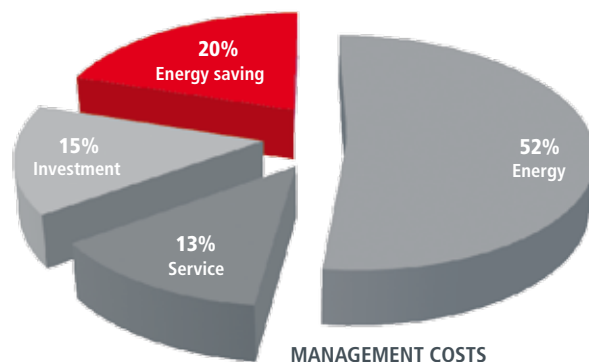

The application of a frequency inverter, able to dynamically adjust the voltage/frequency/current values of the motor, allows the elimination of unnecessary power losses by constantly adjusting the generation of compressed air to match the real air demand, offering many proven advantages for the user in terms of reducing energy consumption:

- ▶ Continuous regulation of the motor speed and compressed air generation to precisely match the air demand.
- ▶ The air output is constantly adjusted between 40% and 100% of the compressor full capacity.
- ▶ Constant and accurate air pressure control selectable at any value between 6 and 10 bar (13 bar on demand).
- ▶ Energy consumption is proportional to the delivered compressed air so you only pay for the compressed air that is used!



# SMS Device Service Management System

SMS is the innovative device for remote control and predictive maintenance of screw compressors fitted with an ETIV controller. If the device is configured on internet networks via Wi-Fi or Ethernet, e-mails can be automatically sent in case of faults and/or automatic periodic e-mails (every hour, every day, every week) so as to monitor correct compressor operation and the remaining hours for the main scheduled maintenance.

## Preventive and targeted maintenance:

- ▶ automatic sending of e-mails in case of alarms,
- ▶ possibility of sending e-mails which notify the compressor status and settings at pre-set intervals (hourly, daily or weekly).

## Remote control of the compressor:

- ▶ no additional software is required,
- ▶ on/off control,
- ▶ access to the various menu levels (user, service),
- ▶ compressor online status check.



9062744

ANTENNA+SMS DEVICE KIT





# EATool - EASoftware Detection and analysis of energy consumption

The energy efficiency of a production plant using compressed air allows for countless advantages for the company's entire production process, in terms of consumption and costs.

Based on decades of experience in the industrial sector, Fini provides a professional auditing service to companies, through skilled technicians and advanced measurement and analysis equipment (EATool and EASoftware). Such equipment allows us to offer one or more rotary screw compressors, in alternative to the existing ones, to achieve considerable annual economic and energy savings.



## EATool

- ▶ Designed to measure pneumatic systems where up to 4 compressors work.
- ▶ Measurements are downloaded to a USB drive (included).
- ▶ Supplied: up to 4 x 400 A ampere clamps (optional up to 1000A) and a pressure probe.
- ▶ Possible equipment sale or rental.

## EASoftware

- ▶ Acquires the actual consumption of a compressed air system.
- ▶ Processes a complete Energy Audit of the system.
- ▶ Suggests one or more compressors as an alternative to the existing ones, to achieve the highest energy savings.

## Optimised control in the compressor room

Many compressed air stations include several compressors: EasyX4 is a weekly programmable sequencer, capable of configuring up to 4 compressors, based on the amount of air actually required.

**EasyX4 is the easiest solution for compressor sequencing and supervision over complex systems of compressors, up to 4 units: fixed speed.**

The programming is intuitive. It is sufficient to set the 4 pressure ranges (if 4 is the number of connected units) and later define at what time the entire compressor station shall start and stop, assigning at which pressure each compressor must work.



### Three programming levels:

- ▶ **MANUAL:** compressors are fixed to a given operational pressure range;
- ▶ **AUTOMATIC:** with pressure range swapping after a programmable time interval;
- ▶ **GROUP PROGRAMMING:** where compressors can be switched within groups.

#405531604 CONTROL UNIT EASY X4

# HRS Heat Recovery System

**HRS is a system for the recovery of the heat generated by the screw compressors, for the production of hot water.**

Most of the energy used to produce compressed air is actually converted into heat: up to 90% of this energy is reusable! About 75% of the energy used is found in the lubrication and cooling circuit and can be used as a heat source, the remaining 15% is contained in the compressed air which enters the network. It is therefore quite simple to recover the thermal energy (for alternative use) in the compression process... valuable energy that is normally wasted!

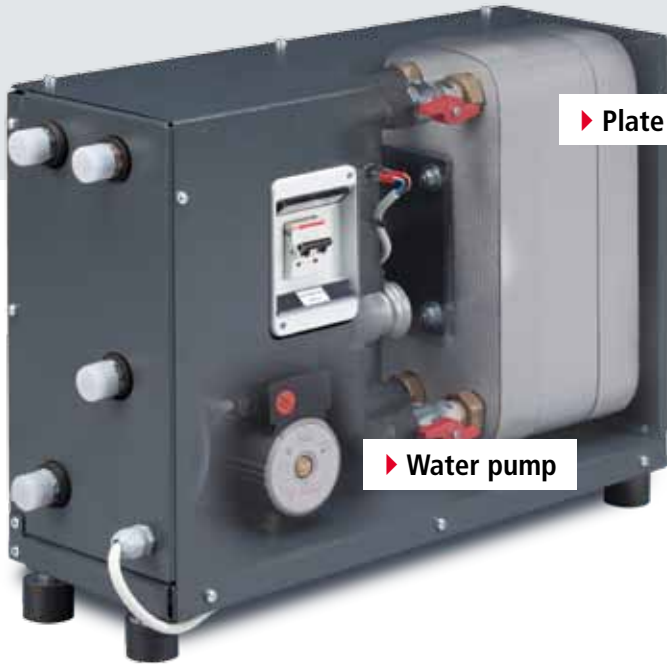

▶ Plate oil-water heat exchanger

▶ Water pump

The HRS system can be used on all oil-injected screw compressors.

## HEAT OF COMPRESSION

- 4% Heat remaining in the air
- 2% Losses by radiation
- 13% Heat removed from the air cooler
- 72% Heat removed from the oil cooler
- 9% Heat radiated by the electric motor

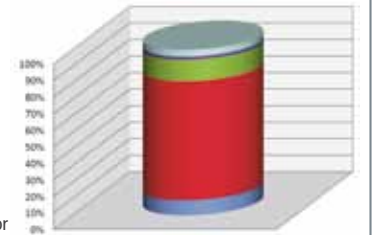

## Recover energy - Save money!

How great the recovery of energy actually is, depends of course on the size of the compressors and the type of replaced energy (electricity, gas, heating oil), but the investment becomes very important for the compressors starting from 11 kW installed power. Given the current energy costs, the return on investment of a typical heat recovery system can be as short as 6 months with less than 2 years being the standard (with reference to a plate heat exchanger for heating systems).

Heat recovery is a real opportunity to increase the effectiveness of a compressed air system, the impact on energy costs allows greater savings, up to 3 times compared to even the most efficient compressor.





# Long Life Kit for screw compressors scheduled maintenance

- ▶ **FSN original spare parts** have been rigorously selected, checked and tested by specialised technicians to ensure the utmost efficiency and endurance of the compressor. The parts are stocked in our "LOGIMAT" centralised and automated warehouse in Zola Predosa (BO) - Italy, where 12,000 part codes on 10,000 sqm are managed every day.
- ▶ Specialised staff are continuously in contact with our distribution centres worldwide, to deliver spare parts to our customers in the shortest possible time.
- ▶ The use of **FSN Long Life Kit**, specifically studied for screw compressors, extends maintenance intervals, cutting down service costs and ensuring consistent product performance.  
**Ask for the catalog with reference codes, suitable for all Micro and Plus compressors.**



## RotarEcofluid mineral based lubricants

- ▶ Formulated with high quality selected mineral base oils enhanced with advanced anti-oxidants, anti-wear (zinc free), rust preventers and antifoams, the FSN RotarECOFLUID oil offers an optimal control of oxidation and residue deposits as well as an excellent level of thermal stability and oxidation to ensure the longevity of equipment and long life performances.

#600000020	Oil RotarECOFLUID 46 cSt - 1 x 3,8 L (3,3 kg) can
#600000021	Oil RotarECOFLUID 46 cSt - 1 x 20 L (17,36 kg) can
#600000022	Oil RotarECOFLUID 46 cSt - 1 x 200 L (174 kg) drum



## RotEnergy synthetic based lubricants

- ▶ Our synthetic based lubricants - FSN RotEnergy - have been specifically designed for use on our screw compressors, supplied by world leading manufacturers. They are available in cans, drums or multi packs: RotEnergyPlus: ensures quick water separation and lower friction and energy consumption, it extends maintenance intervals and ensures excellent lubrication of the bearings while offering excellent protection. RotEnergyFood: a high quality lubricant for rotary compressors, suitable for use in the food industry, where specific quality standards are required.

#600000018A	Oil RotEnergyPlus 46 cSt - 1 x 3,8 L (3,25 kg) can
#600000009A	Oil RotEnergyPlus 46 cSt - 4 x 3,8 L (3,25 kg) each cans
#600000007A	Oil RotEnergyPlus 46 cSt - 1 x 19 L (16 kg) can
#600000012A	Oil RotEnergyPlus 46 cSt - 1 x 208 L (181 kg) drum

#600000014A	Oil RotEnergyFood 46 cSt - 4 x 3,9 L (3,25 kg) each cans
#600000016A	Oil RotEnergyFood 46 cSt - 1 x 19 L (18,5 kg) can
#600000017A	Oil RotEnergyFood 46 cSt - 1 x 208 L (175 kg) drum



- ▶ On the **FINI** website, it is possible to check out the exploded views and spare parts lists for any compressor model whenever needed.

[www.finicompressors.com](http://www.finicompressors.com)



- ▶ Our **Hot-Line** service can prepare and ship urgent spare parts orders within a day (if received before 12.00 p.m.).



Code	ℓ	Product	Compressor		AIR			MAX		dB(A)	G	Weight		L x W x H (cm)
			kW	HP	l/min.	m <sup>3</sup> /h	c.f.m.	bar	psi			kg	Lbs	
<b>FLOOR MOUNTED</b>														
V51JT60FNM560	-	MICRO SE 2.2-10 M	2.2	3	240	14.4	8.5	10	145	58	1/2"	98	216	60 x 48 x 76
V51JU72FNM760	-	MICRO SE 2.2-08	2.2	3	325	19.5	11.5	8	116	58	1/2"	93	205	60 x 48 x 76
V51JT72FNM760	-	MICRO SE 2.2-10	2.2	3	290	17.4	10.2	10	145	58	1/2"	93	205	60 x 48 x 76
V51JS72FNM760	-	MICRO SE 3.0-08	3	4	430	25.8	15.2	8	116	59	1/2"	99	218	60 x 48 x 76
V51JQ72FNM760	-	MICRO SE 3.0-10	3	4	385	23.1	13.6	10	145	59	1/2"	99	218	60 x 48 x 76
V51JR72FNM760	-	MICRO SE 4.0-08	4	5.5	580	34.8	20.5	8	116	60	1/2"	108	238	60 x 48 x 76
V51JP72FNM760	-	MICRO SE 4.0-10	4	5.5	485	29.1	17.1	10	145	60	1/2"	108	238	60 x 48 x 76
V51JR92FNM760	-	MICRO 4.0-08	4	5.5	580	34.8	20.5	8	116	60	1/2"	103	227	60 x 48 x 76
V51JP92FNM760	-	MICRO 4.0-10	4	5.5	485	29.1	17.1	10	145	60	1/2"	103	227	60 x 48 x 76
V51JV92FNM760	-	MICRO 4.0-13	4	5.5	330	19.8	11.6	13	188	60	1/2"	103	227	60 x 48 x 76
V51JW92FNM760	-	MICRO 5.5-08	5.5	7.5	720	43.2	25.4	8	116	64	1/2"	127	279	60 x 52 x 78
V51JO92FNM760	-	MICRO 5.5-10	5.5	7.5	650	39	22.9	10	145	64	1/2"	126	277	60 x 52 x 78
V51JM92FNM760	-	MICRO 5.5-13	5.5	7.5	485	29.1	17.1	13	188	64	1/2"	126	277	60 x 52 x 78
<b>WITH AIR RECEIVER</b>														
V77JT60FNM501	200	MICRO SE 2.2-10 M - 200	2.2	3	240	14.4	8.5	10	145	58	1/2"	149	328	144 x 51 x 128
V77JU72FNM701	200	MICRO SE 2.2-08 - 200	2.2	3	325	19.5	11.5	8	116	58	1/2"	144	317	144 x 51 x 128
V77JT72FNM701	200	MICRO SE 2.2-10 - 200	2.2	3	290	17.4	10.2	10	145	58	1/2"	144	317	144 x 51 x 128
V77JS72FNM701	200	MICRO SE 3.0-08 - 200	3	4	430	25.8	15.2	8	116	59	1/2"	149	328	144 x 51 x 128
V77JQ72FNM701	200	MICRO SE 3.0-10 - 200	3	4	385	23.1	13.6	10	145	59	1/2"	149	328	144 x 51 x 128
V77JR72FNM701	200	MICRO SE 4.0-08 - 200	4	5.5	580	34.8	20.5	8	116	60	1/2"	153	337	144 x 51 x 128
V77JP72FNM701	200	MICRO SE 4.0-10 - 200	4	5.5	485	29.1	17.1	10	145	60	1/2"	153	337	144 x 51 x 128
V77JR92FNM701	200	MICRO 4.0-08 - 200	4	5.5	580	34.8	20.5	8	116	60	1/2"	149	328	144 x 51 x 128
V77JP92FNM701	200	MICRO 4.0-10 - 200	4	5.5	485	29.1	17.1	10	145	60	1/2"	149	328	144 x 51 x 128
V91JW92FNM701	270	MICRO 5.5-08 - 270	5.5	7.5	720	43.2	25.4	8	116	64	1/2"	202	444	156 x 57 x 139
V91JO92FNM701	270	MICRO 5.5-10 - 270	5.5	7.5	650	39	22.9	10	145	64	1/2"	202	444	156 x 57 x 139
V83JW92FNM701	500	MICRO 5.5-08 - 500	5.5	7.5	720	43.2	25.4	8	116	64	1/2"	247	543	200 x 60 x 148
V83JO92FNM701	500	MICRO 5.5-10 - 500	5.5	7.5	650	39	22.9	10	145	64	1/2"	247	543	200 x 60 x 148
<b>WITH AIR RECEIVER AND DRYER</b>														
V77JU72FNM801	200	MICRO SE 2.2-08 - 200 ES	2.2	3	325	19.5	11.5	8	116	58	1/2"	162	356	144 x 51 x 128
V77JT72FNM801	200	MICRO SE 2.2-10 - 200 ES	2.2	3	290	17.4	10.2	10	145	58	1/2"	162	356	144 x 51 x 128
V77JS72FNM801	200	MICRO SE 3.0-08 - 200 ES	3	4	430	25.8	15.2	8	116	59	1/2"	179	394	144 x 51 x 128
V77JQ72FNM801	200	MICRO SE 3.0-10 - 200 ES	3	4	385	23.1	13.6	10	145	59	1/2"	179	394	144 x 51 x 128
V77JR72FNM801	200	MICRO SE 4.0-08 - 200 ES	4	5.5	580	34.8	20.5	8	116	60	1/2"	171	376	144 x 51 x 128
V77JP72FNM801	200	MICRO SE 4.0-10 - 200 ES	4	5.5	485	29.1	17.1	10	145	60	1/2"	171	376	144 x 51 x 128
V77JR92FNM801	200	MICRO 4.0-08 - 200 ES	4	5.5	580	34.8	20.5	8	116	60	1/2"	167	367	144 x 51 x 128
V77JP92FNM801	200	MICRO 4.0-10 - 200 ES	4	5.5	485	29.1	17.1	10	145	60	1/2"	167	367	144 x 51 x 128
V91JW92FNM801	270	MICRO 5.5-08 - 270 ES	5.5	7.5	720	43.2	25.4	8	116	64	1/2"	229	504	156 x 57 x 139
V91JO92FNM801	270	MICRO 5.5-10 - 270 ES	5.5	7.5	650	39	22.9	10	145	64	1/2"	229	504	156 x 57 x 139
V83JW92FNM801	500	MICRO 5.5-08 - 500 ES	5.5	7.5	720	43.2	25.4	8	116	64	1/2"	277	609	200 x 60 x 148
V83JO92FNM801	500	MICRO 5.5-10 - 500 ES	5.5	7.5	650	39	22.9	10	145	64	1/2"	277	609	200 x 60 x 148

Free air delivery as per ISO 1217 Annex C, at 7.5 - 9.5 - 12.5 bar at the compressor outlet. ± 3 dB (A) as PNEUROP/CAGI PN-NTC 2.3.











Code	ℓ	Product	Compressor		AIR			MAX		dB(A)	BSP	Weight		L x W x H (cm)
			kW	HP	l/min.	m <sup>3</sup> /h	c.f.m.	bar	psi			kg	Lbs	
<b>FLOOR MOUNTED</b>														
V60NG92FNM760	-	PLUS 8-08	7.5	10	1250	75	44.1	8	116	68	3/4"	205	451	80 x 65 x 98
V60NH92FNM760	-	PLUS 8-10	7.5	10	1000	60	35.3	10	145	68	3/4"	205	451	80 x 65 x 98
V60NI92FNM760	-	PLUS 8-13	7.5	10	750	45	26.5	13	188	68	3/4"	205	451	80 x 65 x 98
V60NL92FNM760	-	PLUS 11-08	11	15	1650	99	58.2	8	116	69	3/4"	216	475	80 x 65 x 98
V60NM92FNM760	-	PLUS 11-10	11	15	1500	90	53	10	145	69	3/4"	216	475	80 x 65 x 98
V60NN92FNM760	-	PLUS 11-13	11	15	1100	66	38.8	13	188	69	3/4"	216	475	80 x 65 x 98
V60NP92FNM760	-	PLUS 15-08	15	20	2150	129	75.9	8	116	70	3/4"	220	484	80 x 65 x 98
V60NQ92FNM760	-	PLUS 15-10	15	20	1850	111	65.3	10	145	70	3/4"	220	484	80 x 65 x 98
V60NR92FNM760	-	PLUS 15-13	15	20	1500	90	53	13	188	70	3/4"	220	484	80 x 65 x 98
V60NB92FNM760	-	PLUS 16-08	15	20	2350	141	83	8	116	68	3/4"	234,5	516	80 x 65 x 98
V60NY92FNM760	-	PLUS 16-10	15	20	2050	123	72.4	10	145	68	3/4"	234,5	516	80 x 65 x 98
V60NW92FNM760	-	PLUS 16-13	15	20	1750	105	61.8	13	188	68	3/4"	234,5	516	80 x 65 x 98
<b>WITH AIR RECEIVER</b>														
V91NG92FNM701	270	PLUS 8-08-270	7.5	10	1250	75	44.1	8	116	68	3/4"	288	634	156 x 65 x 155
V91NH92FNM701	270	PLUS 8-10-270	7.5	10	1000	60	35.3	10	145	68	3/4"	288	634	156 x 65 x 155
V91NL92FNM701	270	PLUS 11-08-270	11	15	1650	99	58.2	8	116	69	3/4"	302	664	156 x 65 x 155
V91NM92FNM701	270	PLUS 11-10-270	11	15	1500	90	53	10	145	69	3/4"	302	664	156 x 65 x 155
V83NG92FNM701	500	PLUS 8-08-500	7.5	10	1250	75	44.1	8	116	68	3/4"	334	735	200 x 65 x 164
V83NH92FNM701	500	PLUS 8-10-500	7.5	10	1000	60	35.3	10	145	68	3/4"	334	735	200 x 65 x 164
V83NL92FNM701	500	PLUS 11-08-500	11	15	1650	99	58.2	8	116	69	3/4"	353	777	200 x 65 x 164
V83NM92FNM701	500	PLUS 11-10-500	11	15	1500	90	53	10	145	69	3/4"	353	777	200 x 65 x 164
V83NP92FNM701	500	PLUS 15-08-500	15	20	2150	129	75.9	8	116	70	3/4"	383	843	200 x 65 x 164
V83NQ92FNM701	500	PLUS 15-10-500	15	20	1850	111	65.3	10	145	70	3/4"	383	843	200 x 65 x 164
V83NB92FNM701	500	PLUS 16-08-500	15	20	2350	141	83	8	116	68	3/4"	410	902	200 x 65 x 164
V83NY92FNM701	500	PLUS 16-10-500	15	20	2050	123	72.4	10	145	68	3/4"	362	796	200 x 65 x 164
<b>WITH AIR RECEIVER AND DRYER</b>														
V91NG92FNM801	270	PLUS 8-08-270 ES	7.5	10	1250	75	44.1	8	116	68	3/4"	315	693	156 x 65 x 155
V91NH92FNM801	270	PLUS 8-10-270 ES	7.5	10	1000	60	35.3	10	145	68	3/4"	315	693	156 x 65 x 155
V91NL92FNM801	270	PLUS 11-08-270 ES	11	15	1650	99	58.2	8	116	69	3/4"	329	724	156 x 65 x 155
V91NM92FNM801	270	PLUS 11-10-270 ES	11	15	1500	90	53	10	145	69	3/4"	329	724	156 x 65 x 155
V83NG92FNM801	500	PLUS 8-08-500 ES	7.5	10	1250	75	44.1	8	116	68	3/4"	361	794	200 x 65 x 164
V83NH92FNM801	500	PLUS 8-10-500 ES	7.5	10	1000	60	35.3	10	145	68	3/4"	361	794	200 x 65 x 164
V83NL92FNM801	500	PLUS 11-08-500 ES	11	15	1650	99	58.2	8	116	69	3/4"	380	836	200 x 65 x 164
V83NM92FNM801	500	PLUS 11-10-500 ES	11	15	1500	90	53	10	145	69	3/4"	380	836	200 x 65 x 164
V83NP92FNM801	500	PLUS 15-08-500 ES	15	20	2150	129	75.9	8	116	70	3/4"	412	906	200 x 65 x 164
V83NQ92FNM801	500	PLUS 15-10-500 ES	15	20	1850	111	65.3	10	145	70	3/4"	412	906	200 x 65 x 164
V83NB92FNM801	500	PLUS 16-08-500 ES	15	20	2350	141	83	8	116	68	3/4"	439	966	200 x 65 x 164
V83NY92FNM801	500	PLUS 16-10-500 ES	15	20	2050	123	72.4	10	145	68	3/4"	436	959	200 x 65 x 164

ALL MODELS WITH AIR RECEIVER ARE ALSO AVAILABLE ON REQUEST WITH A WORKING PRESSURE OF 13 BAR, PROVIDING THE SAME PERFORMANCE OF MODELS ON GROUND.  
Free air delivery as per ISO 1217 Annex C, at 7.5 - 9.5 - 12.5 bar at the compressor outlet. ± 3 dB (A) as PNEUROP/CAGI PN-NTC 2.3.









Code	Product			 AIR **			 MAX						
		kW	HP	l/min.	m <sup>3</sup> /h	c.f.m.	bar	psi	dB(A)	BSP	kg	Lbs	L x W x H (cm)
<b>FLOOR MOUNTED</b>													
<b>V60QA92FNM760</b>	PLUS 18.5-08	18.5	25	2800	168	99	8	116	66	3/4"	350	774	135 x 80 x 113
<b>V60QB92FNM760</b>	PLUS 18.5-10	18.5	25	2500	150	88	10	145	66	3/4"	350	774	135 x 80 x 113
<b>V60QC92FNM760</b>	PLUS 18.5-13	18.5	25	2150	129	76	13	188	66	3/4"	350	774	135 x 80 x 113
<b>V60QD92FNM760</b>	PLUS 22-08	22	30	3350	201	118	8	116	68	3/4"	380	840	135 x 80 x 113
<b>V60QE92FNM760</b>	PLUS 22-10	22	30	3000	180	106	10	145	68	3/4"	380	840	135 x 80 x 113
<b>V60QF92FNM760</b>	PLUS 22-13	22	30	2400	144	85	13	188	68	3/4"	380	840	135 x 80 x 113
<b>WITH DRYER</b>													
<b>V60QA92FNM860</b>	PLUS 18.5-08 ES	18.5	25	2800	168	99	8	116	66	3/4"	400	883	169 x 80 x 113
<b>V60QB92FNM860</b>	PLUS 18.5-10 ES	18.5	25	2500	150	88	10	145	66	3/4"	400	883	169 x 80 x 113
<b>V60QC92FNM860</b>	PLUS 18.5-13 ES	18.5	25	2150	129	76	13	188	66	3/4"	400	883	169 x 80 x 113
<b>V60QD92FNM860</b>	PLUS 22-08 ES	22	30	3350	201	118	8	116	68	3/4"	430	949	169 x 80 x 113
<b>V60QE92FNM860</b>	PLUS 22-10 ES	22	30	3000	180	106	10	145	68	3/4"	430	949	169 x 80 x 113
<b>V60QF92FNM860</b>	PLUS 22-13 ES	22	30	2400	144	85	13	188	68	3/4"	430	949	169 x 80 x 113
<b>VARIABLE SPEED</b>													
<b>V60QD97FNM760</b>	PLUS 22-08 VS	22	30	3350 / 1350	201 / 81	118 / 48	8	116	68	3/4"	390	861	135 x 80 x 113
<b>V60QE97FNM760</b>	PLUS 22-10 VS	22	30	3050 / 1220	183 / 73.2	108 / 43	10	145	68	3/4"	390	861	135 x 80 x 113
<b>VARIABLE SPEED WITH DRYER</b>													
<b>V60QD97FNM860</b>	PLUS 22-08 ES VS	22	30	3350 / 1350	201 / 81	118 / 48	8	116	68	3/4"	440	971	169 x 80 x 113
<b>V60QE97FNM860</b>	PLUS 22-10 ES VS	22	30	3050 / 1220	183 / 73.2	108 / 43	10	145	68	3/4"	440	971	169 x 80 x 113

Free air delivery as per ISO 1217 Annex C, at 7.5 - 9.5 - 12.5 bar at the compressor outlet.  $\pm 3$  dB (A) as PNEUROP/CAGI PN-NTC 2.3.

\*\* Variable Speed models: max./min. values.



Code	Product			 AIR **			 MAX.						
		kW	HP	l/min.	m <sup>3</sup> /h	c.f.m.	bar	psi	dB(A)	BSP	kg	Lbs	L x W x H (cm)
<b>FLOOR MOUNTED</b>													
V60BU92FNM760	PLUS 31-08	30	40	4700	282	165.9	8	116	70	1 -1/4"	630	1392	153 x 83 x 144
V60BV92FNM760	PLUS 31-10	30	40	4200	252	148.3	10	145	70	1 -1/4"	630	1392	153 x 83 x 144
V60BW92FNM760	PLUS 31-13	30	40	3400	204	120	13	188	70	1 -1/4"	630	1392	153 x 83 x 144
V60BK92FNM760	PLUS 38-08	37	50	6000	360	212	8	116	68	1 -1/4"	700	1547	153 x 83 x 144
V60BJ92FNM760	PLUS 38-10	37	50	5300	318	187	10	145	68	1 -1/4"	700	1547	153 x 83 x 144
V60BI92FNM760	PLUS 38-13	37	50	4000	240	141	13	188	68	1 -1/4"	700	1547	153 x 83 x 144
V60BM92FNM860	PLUS 45-08	45	60	7200	432	254	7.5	109	72	1 -1/2"	910	2002	160 x 97 x 186
V60BN92FNM860	PLUS 45-10	45	60	6500	390	229	10	145	72	1 -1/2"	910	2002	160 x 97 x 186
V60BQ92FNM860	PLUS 45-13	45	60	5100	306	180	13	188	72	1 -1/2"	910	2002	160 x 97 x 186
V60BR92FNM760	PLUS 55-08	55	75	8600	516	304	7.5	109	74	1 -1/2"	952	2094	160 x 97 x 186
V60BS92FNM760	PLUS 55-10	55	75	7800	468	275	10	145	74	1 -1/2"	952	2094	160 x 97 x 186
V60BT92FNM760	PLUS 55-13	55	75	6400	384	226	13	188	74	1 -1/2"	952	2094	160 x 97 x 186
V60BA92FNM760	PLUS 56-08	55	75	9300	558	328	7.5	109	70	2"	1650	3630	180 x 110 x 215
V60BB92FNM760	PLUS 56-10	55	75	8300	498	293	10	145	70	2"	1650	3630	180 x 110 x 215
V60BC92FNM760	PLUS 56-13	55	75	7000	420	247	13	188	70	2"	1650	3630	180 x 110 x 215
V60BD92FNM760	PLUS 75-08	75	100	12200	732	431	7.5	109	72	2"	1720	3784	180 x 110 x 215
V60BE92FNM760	PLUS 75-10	75	100	10500	630	371	10	145	72	2"	1720	3784	180 x 110 x 215
V60BF92FNM760	PLUS 75-13	75	100	8300	498	293	13	188	72	2"	1720	3784	180 x 110 x 215
<b>WITH DRYER</b>													
V60BU92FNM860	PLUS 31-08 ES	30	40	4700	282	165.9	8	116	70	1 -1/4"	710	1567	153 x 83 x 144
V60BV92FNM860	PLUS 31-10 ES	30	40	4200	252	148.3	10	145	70	1 -1/4"	710	1567	153 x 83 x 144
V60BW92FNM860	PLUS 31-13 ES	30	40	3400	204	120	13	188	70	1 -1/4"	710	1567	153 x 83 x 144
V60BK92FNM860	PLUS 38-08 ES	37	50	6000	360	212	8	116	68	1 -1/4"	780	1721	186 x 83 x 144
V60BJ92FNM860	PLUS 38-10 ES	37	50	5300	318	187	10	145	68	1 -1/4"	780	1721	186 x 83 x 144
V60BI92FNM860	PLUS 38-13 ES	37	50	4000	240	141	13	188	68	1 -1/4"	780	1721	186 x 83 x 144
<b>VARIABLE SPEED</b>													
V60BK97FNM760	PLUS 38-08 VS	37	50	5900 / 2350	354 / 141	208 / 83	8	116	72	1 -1/4"	725	1600	153 x 83 x 144
V60BJ97FNM760	PLUS 38-10 VS	37	50	5200 / 2050	312 / 123	184 / 72	10	145	72	1 -1/4"	725	1600	153 x 83 x 144
V60BA97FNM760	PLUS 56-08 VS	55	75	9300 / 3700	558 / 222	328 / 131	7.5	109	70	2"	1686	3721	180 x 110 x 215
V60BB97FNM760	PLUS 56-10 VS	55	75	8300 / 3300	498 / 198	293 / 116	10	145	70	2"	1686	3721	180 x 110 x 215
V60BD97FNM760	PLUS 75-08 VS	75	100	12200 / 4800	732 / 288	431 / 169	7.5	109	72	2"	1756	3875	180 x 110 x 215
V60BE97FNM760	PLUS 75-10 VS	75	100	10500 / 4200	630 / 252	371 / 148	10	145	72	2"	1756	3875	180 x 110 x 215
<b>VARIABLE SPEED WITH DRYER</b>													
V60BK97FNM860	PLUS 38-08 ES VS	37	50	5900 / 2350	354 / 141	208 / 83	8	116	72	1 -1/4"	805	1777	186 x 83 x 144
V60BJ97FNM860	PLUS 38-10 ES VS	37	50	5200 / 2050	312 / 123	184 / 72	10	145	72	1 -1/4"	805	1777	186 x 83 x 144

Free air delivery as per ISO 1217 Annex C, at 7.5 - 9.5 - 12.5 bar at the compressor outlet.  $\pm 3$  dB (A) as PNEUROP/CAGI PN-NTC 2.3.

\*\* Variable Speed models: max./min. values.

## A wide range of solutions for industrial applications



### **K-Max 5,5-37**

Oil injection rotary screw compressors, with direct transmission without gears, at fixed or variable speed, and power values from 5.5 to 37 kW.



### **K-Max 45-90**

Oil injection rotary screw compressors, with direct transmission without gears, from 45 to 90 kW.



### **Tera SD**

Oil injection rotary screw compressors, with direct transmission without gears, at fixed or variable speed, and power values from 75 to 250 kW.



### **OS Scroll**

Oil-free compressors with scroll spiral rotary system, at fixed or variable speed, and power values from 2.2 to 30 kW.



### **Trattamento Aria**

Driers, filters, accessories and a vast range of products for compressed air treatment.



### **FNA S.p.A.**

*Production plant, registered office and Headquarter: Via Einaudi, 6 - 10070 Robassomero (TO) Italy*

*Tel. +39 011 9233000 - Fax +39 011 9241138*

*Production plant: Via Toscana, 21 - 40069 Zola Predosa (BO) Italy*

*Tel. 051 6168111 - Fax 051 752408*

[www.finicompressors.com](http://www.finicompressors.com) - [info@fnacompressors.com](mailto:info@fnacompressors.com)

